

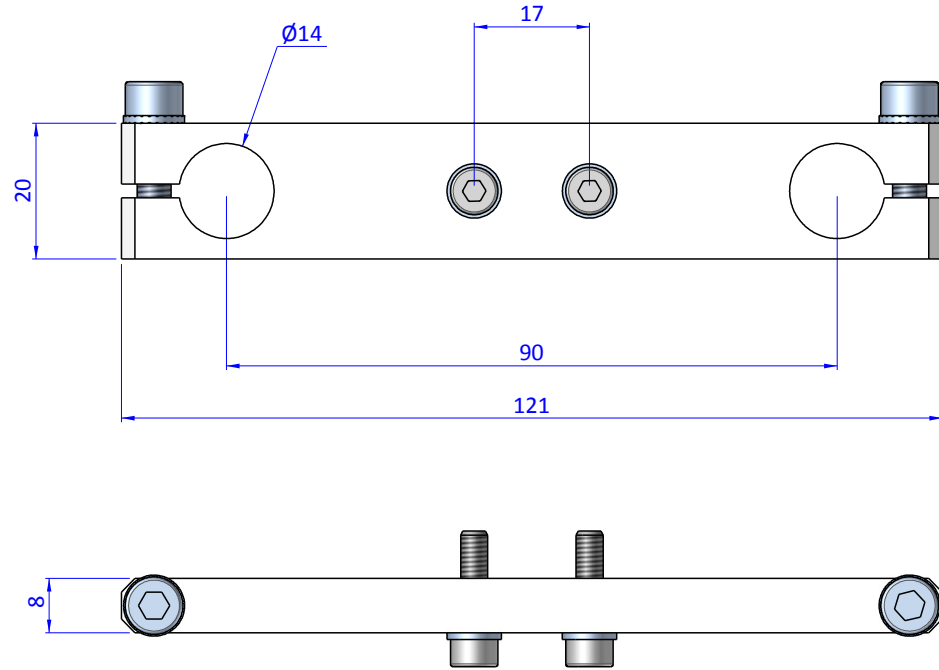

THE PROPERTY OF THE DRAWING IS ESTABLISHED BY LAW. IT IS FORBIDDEN TO PRODUCE OR SHOW IT TO THIRD PARTY, WITHOUT A WRITTEN AGREEMENT.

Item	Name	Q.ty
1	KBH.20.14.90	1
2	R.4	2
3	R.5.SCH	2
4	V.TCE4x16	2
5	V.TCE5x20	2

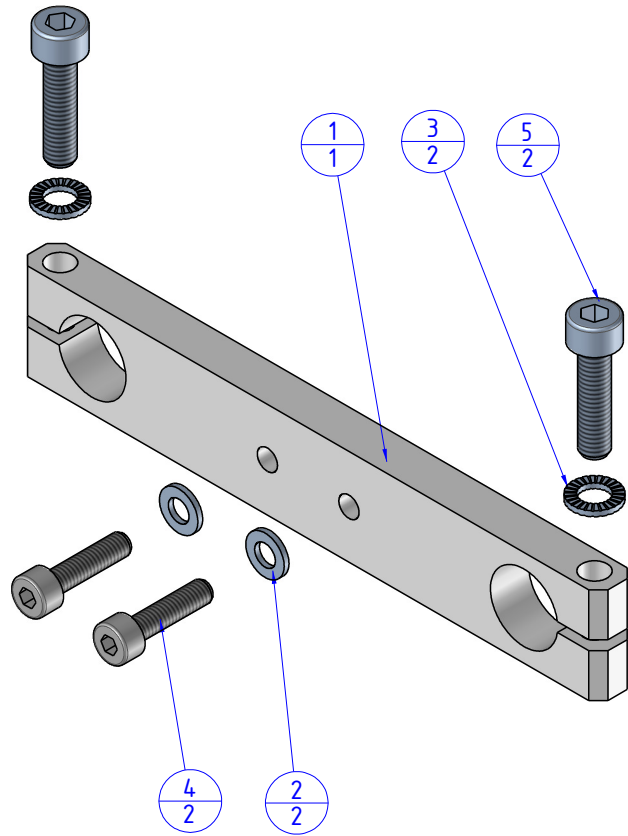

Format A3

UNI 936-76

 <b>FPS</b> FPSERVICES AUTOMATION		DESIGNED FROM		REVIEW
		FPS Automation		A
GENERAL TOLERANCE		DATE	WEIGHT	
UNI - ISO 2768		20/05/2019	0,058kg	
CLASSE f		CODE		
		CA.KBH.20.14.90		CA.KBH.20.14.90